

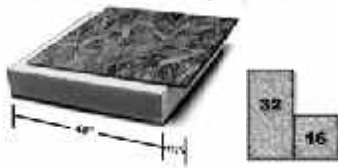

**SOL-R-BLOCK R-13.5**  
 Panels that are easy to handle



Standard KD-Building Packages are simple to ship or even put in the back of a utility truck



(Frame Packages are Max 8' Long)  
 Local Delivery is available

**Frame Package:**  
 2" x 3"-14 Gauge Galvanized Steel Tube Frame From 7' 6" to 12' 6" eave height building

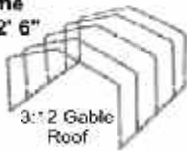

**Sleeve Connection 4" to 6"**  
 KD-Structure is easily put together using this system making installation quick and simple.



**GALVANIZED SUB GIRTS**



SG1 - 20' 1/2" x 3.5" 18 ga.  
 SG2 - 20' 3/4" x 3.5" 16 ga.

**PRE-FAB**

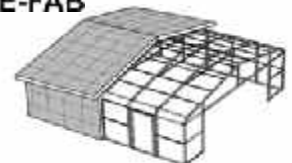

**BUILDING ENVELOPE**

**INSULATED PANELS**  
 No Sagging Insulation / Purlins and Girts do not compress insulation and reduce R value. Guaranteed Savings on your utility bills.



**STEEL WHERE YOU NEED IT  
 WOOD WHERE YOU NAIL IT**



**VINYL SIDING R-4.5**



Insulating properties absorb sound and save energy



**2" x 3" Tube GV Series**  
 Engineered Tubular Steel Framing Systems  
 40# Snow  
 90 mph Wind

# KD-STEEL STRUCTURES

## BY JOHNSON BUILDING SYSTEMS

### with SOL-R-BLOCK 4" Insulated Panels

 Johnson Building Systems, Inc.  
 975 Jaymor Rd  
 Southampton, PA 18966-3854  
 215-673-6050 or Fax: 215-322-2076  
 www.JohnsonBuildingSystems.com

**SUPPLY AND DESIGN 1-800-445-7249**  
**SHIP ANYWHERE**



# PRE-FABRICATED STRUCTURAL Solid Core Building Packages

## SOL-R-BLOCK OVERLAPPING SOLID CORE 4" PANEL SYSTEM



**SUPER INSULATED STRUCTURES**

**Preferred Solid Core Construction**

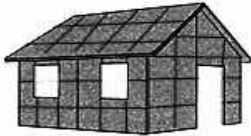

**Ordinary Stick Construction**

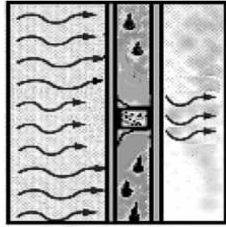
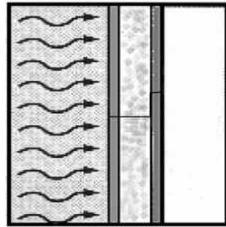
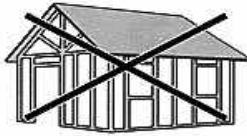

**4" STRUCTURAL INSULATED PANELS**  
No sagging insulation, Purlins and Girts do not compress insulation and reduce R-value, No air infiltration, Guaranteed Savings on your utility bills.

### Timber Frame

**THERMAL BENEFITS:**

**SOL-R-BLOCK SOLID CORE PANEL**, fabricated by Johnson Building Systems, was developed to eliminate conventional wall framing between the structural members of post and steel framed buildings. It attaches to the frame system and adds to the energy efficiency and sound attenuation of the structure.

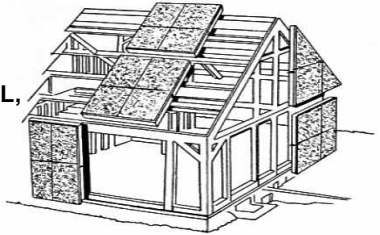

### KD-Steel Tubular Frame System

8' High Eave Frame Buildings		Length (Ft)				
		20	30	40	50	60
Width (Ft)	10	\$10.70	\$9.90	\$9.50	\$9.40	\$9.20
	12	\$10.70	\$9.50	\$8.90	\$8.60	\$8.40
	14	\$9.90	\$8.80	\$8.10	\$7.80	\$7.50
	16	\$9.80	\$8.50	\$7.80	\$7.50	\$7.20
	18	\$9.50	\$8.10	\$7.50	\$7.10	\$6.80
	20	\$9.40	\$8.10	\$7.30	\$7.10	\$6.80
	24	\$9.40	\$8.10	\$7.30	\$6.90	\$6.60
30	\$9.20	\$7.80	\$6.90	\$6.50	\$6.30	
10' High Eave Frame Buildings		Length (Ft)				
		20	30	40	50	60
Width (Ft)	10	\$11.50	\$10.20	\$9.80	\$9.50	\$9.40
	12	\$11.50	\$9.80	\$9.10	\$8.60	\$8.50
	14	\$11.30	\$8.90	\$8.20	\$7.90	\$7.60
	16	\$10.20	\$8.60	\$7.90	\$7.50	\$7.20
	18	\$9.80	\$8.20	\$7.50	\$7.10	\$6.80
	20	\$9.90	\$8.20	\$7.50	\$7.20	\$6.90
	24	\$9.90	\$8.10	\$7.30	\$7.10	\$6.80
30	\$9.60	\$7.80	\$7.10	\$6.60	\$6.50	
12' High Eave Frame Buildings		Length (Ft)				
		20	30	40	50	60
Width (Ft)	10	\$11.90	\$10.40	\$9.90	\$9.60	\$9.50
	12	\$12.30	\$9.90	\$9.20	\$8.80	\$8.60
	14	\$11.80	\$9.10	\$8.30	\$7.90	\$7.60
	16	\$10.90	\$8.80	\$8.10	\$7.60	\$7.30
	18	\$10.50	\$8.40	\$7.60	\$7.20	\$6.90
	20	\$10.40	\$8.40	\$7.60	\$7.20	\$6.90
	24	\$10.40	\$8.20	\$7.50	\$7.10	\$6.80
30	\$10.10	\$7.90	\$7.10	\$6.60	\$6.60	

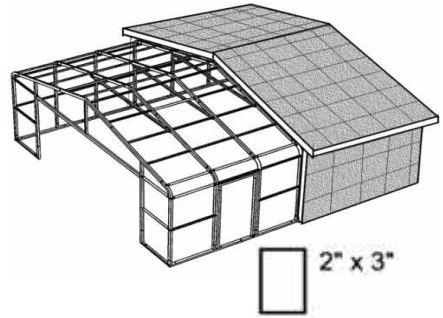

Standard KD Tubular Frame 8' Building Packages are simple to ship crated or even put in the back of a utility truck.

**EASY TO BUILD** with readily available tools and equipment for ease of construction. Install in days not months.

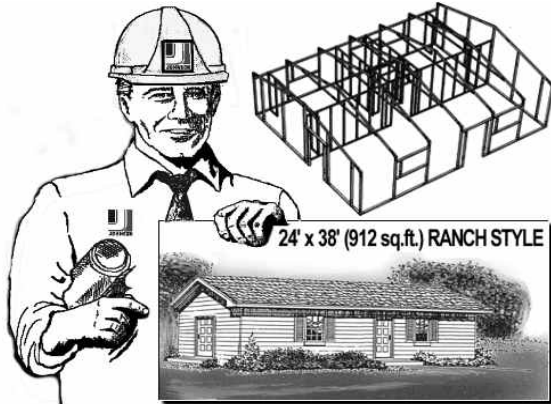

**STEEL WHERE YOU NEED IT  
WOOD WHERE YOU NAIL IT**

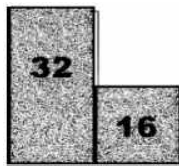

Description			Net Price/Sq.Ft.	
7/16" OSB - Both Sides			3" EPS	3" ISO
			R-13.5	R-23.5
48" x 48"	<b>SOL-R-BLOCK-16</b>	4' x 4' - 16 Sq.Ft.	\$4.60	\$5.10
48" x 96"	<b>SOL-R-BLOCK-32</b>	4' x 8' - 32 Sq.Ft.	\$4.50	\$5.00
Add: White .035" FRP Laminated to Underside of Roof Panel			\$1.35	

Net Price FOB Southampton, PA - Shipping 2-3 Weeks ARO. Budget Freight add 10% to Above Net Price.